

## Install the Eclipt Core drive in the HP Zbook Fury G7

**Note:** you need a SATA bracket (part nr. M17041-001) in advanced to proceed with the below installation

**Step 1.** Pull the button to Right and then push the backside towards you as stated in the picture below



**Step 2.** Take of the battery off by clicking the two buttons to left simultaneously and pull battery out

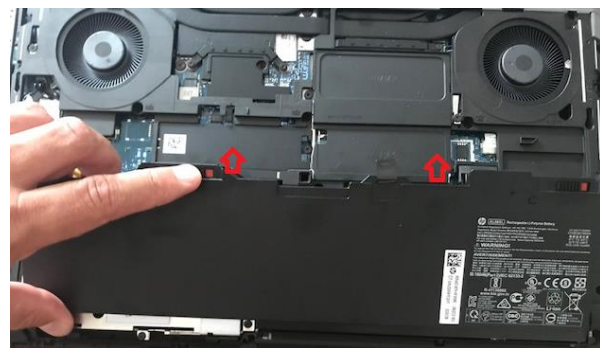
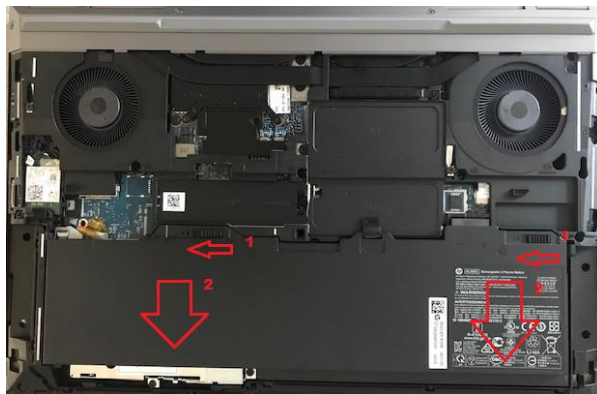

**Step 3.** Take out the 3 screws as stated below

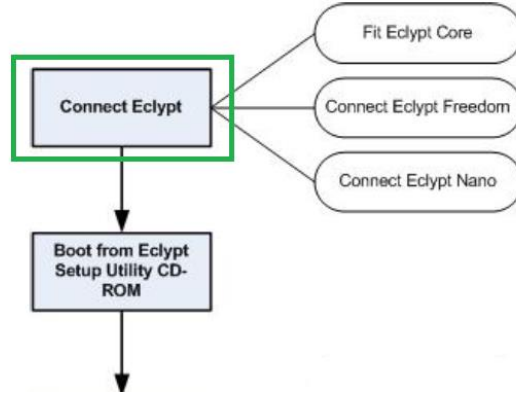
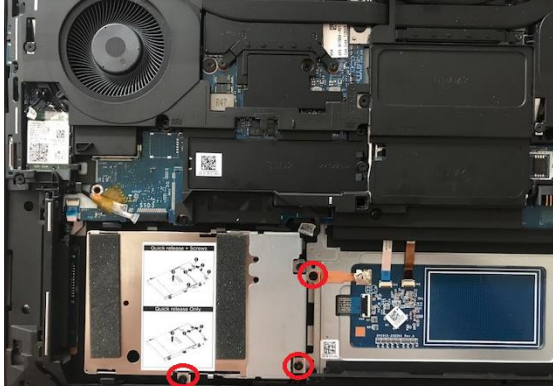

**Step 4.** Connect the Viasat Core Drive in the bracket as stated below

**Note:** be sure the Power and SATA connector is well connected

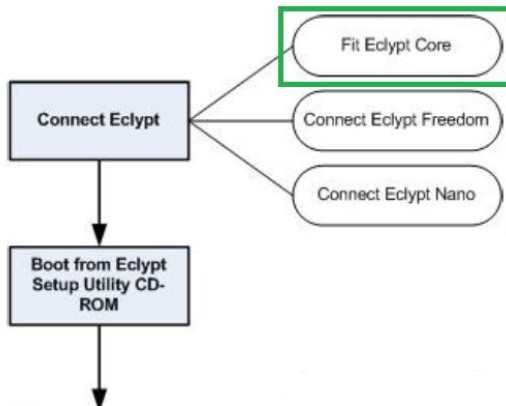

**Step 5.** Connect the Viasat Core 200 drive and close the cover

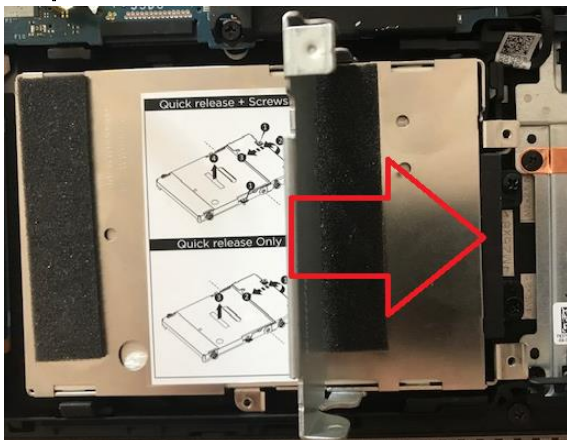

**Step 6.** Screw the screws back (See step 3) and close the backside of the laptop

**Step 7.** Turn on the button on the keyboard and **hold F10** to get access to the BIOS Setup menu.

**Step 8.** Go the **Advanced** menu, **disable M.2 SSD** or take it off and **move the Viasat SSD UP** in the Boot Order.

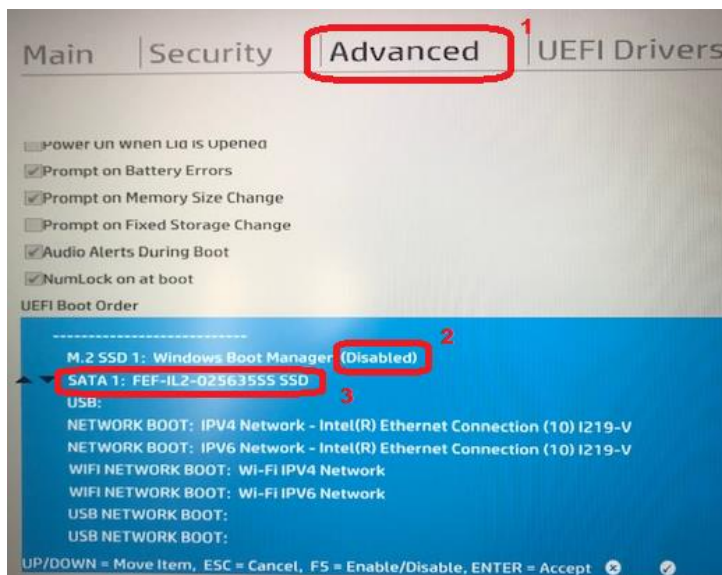

**Step 9.** Before we save these settings. **Load the ECLYPT DVD** to start up the Initialization and Authentication (PEA = Pre-Authentication Environment).

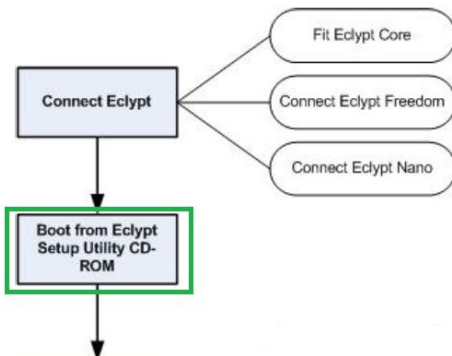



**Note 1.** You need to download the PDF **CO Guide** also from the DVD and you can follow the instructions from **page 72** chapter **"10. PRE AUTHENTICATION ENVIRONMENT"**. To get access to the PAE you need to **insert the Viasat DVD** and **boot** from it.

**Note 2.** Read the instructions first before proceeding the Initialization and authentication.

**Step 10.** Via the BIOS – go the **Main menu** and proceed with **Save settings**.